

■ **XCKM,**
with 3 cable entries

□ With head for linear movement
(plunger)

□ With head for rotary movement
(lever) or multi-directional

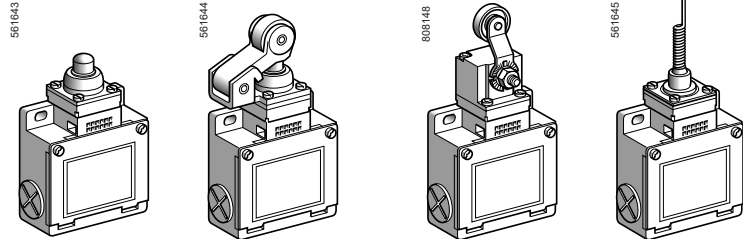

Page 118

■ **XCKL,**
with 1 cable entry

□ With head for linear movement
(plunger)

□ With head for rotary movement
(lever) or multi-directional

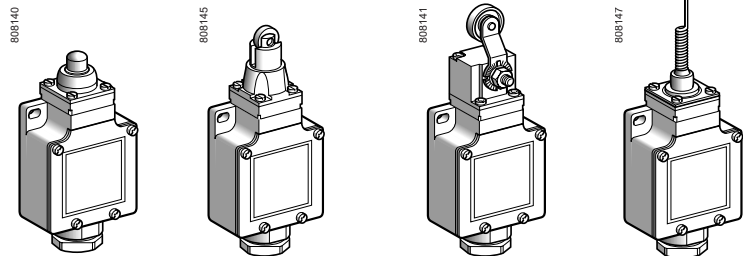

Page 120

■ **XCKML,**
with 3 cable entries and 2 x 2-pole contacts

□ With head for linear movement
(plunger)

□ With head for rotary movement
(lever)

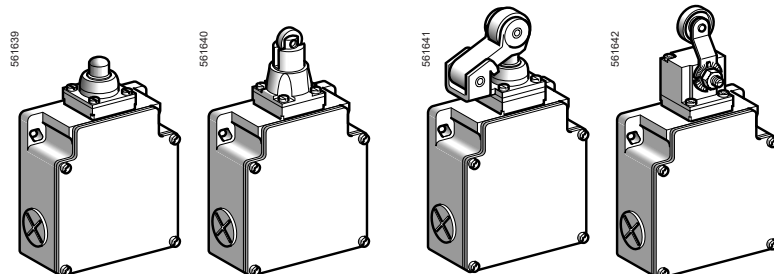

Page 122

Environment characteristics

Conformity to standards	Products	IEC 60947-5-1, EN 60947-5-1, UL 508, CSA C22-2 n° 14
	Machine assemblies	IEC 60204-1, EN 60204-1
Product certifications		UL, CSA CCC (only for XCKM) BV (only for XCKM and XCKL)
Protective treatment	Version	Standard: "TC". Special: "TH"
Ambient air temperature	For operation	- 25...+ 70°C
	For storage	- 40...+ 70°C
Vibration resistance	Conforming to IEC 60068-2-6	25 gn (10...500 Hz)
Shock resistance	Conforming to IEC 60068-2-27	50 gn (11 ms)
Electric shock protection		Class I conforming to IEC 61140 and NF C 20-030
Degree of protection		IP 66 conforming to IEC 60529; IK 05 conforming to IEC 62262
Repeat accuracy		XCKML 0.1 mm; XCKM and XCKL 0.05 mm on the tripping points, with 1 million operating cycles for head with end plunger
Cable entry or connector	Depending on model	XCKM : 3 tapped entries for Pg 11 cable gland or tapped ISO M20, or with 1/2" NPT adaptor XCKL : 1 tapped entry incorporating Pg 13.5 cable gland or 1 entry tapped 1/2" NPT XCKML : 3 tapped entries for Pg 13.5 cable gland or tapped ISO M20
Materials		Bodies: Zamak. Rotary heads: Zamak or plastic, depending on product reference. Other heads: plastic

Contact block characteristics		
Rated operational characteristics	XE2●P	~ AC-15; A300 (Ue = 240 V, Ie = 3 A); Ithe = 10 A --- DC-13; Q300 (Ue = 250 V, Ie = 0.27 A), conforming to IEC 60947-5-1 Appendix A, EN 60947-5-1
	XE3●P	~ AC-15; B300 (Ue = 240 V, Ie = 1.5 A); Ithe = 6 A --- DC-13; R300 (Ue = 250 V, Ie = 0.1 A), conforming to IEC 60947-5-1 Appendix A, EN 60947-5-1
Rated insulation voltage	XE2●P	Ui = 500 V degree of pollution 3 conforming to IEC 60947-1 Ui = 300 V conforming to UL 508, CSA C22-2 n° 14
	XE3●P	Ui = 400 V degree of pollution 3 conforming to IEC 60947-1 Ui = 300 V conforming to UL 508, CSA C22-2 n° 14
Rated impulse withstand voltage	XE2●P	U imp = 6 kV conforming to IEC 60947-1, IEC 60664
	XE3●P	U imp = 4 kV conforming to IEC 60947-1, IEC 60664
Positive operation (depending on model)		NC contacts with positive opening operation conforming to IEC 60947-5-1 Appendix K, EN 60947-5-1
Resistance across terminals		≤ 25 mΩ conforming to IEC 60255-7 category 3
Short-circuit protection	XE2●P	10 A cartridge fuse type gG (gl)
	XE3●P	6 A cartridge fuse type gG (gl)
Connection (screw clamp terminals)	XE2SP21●1	Clamping capacity, min: 1 x 0.34 mm ² , max: 2 x 1.5 mm ²
	XE2NP21●1	Clamping capacity, min: 1 x 0.5 mm ² , max: 2 x 2.5 mm ²
	XESP2151L and XENP2151L	Clamping capacity, min: 1 x 0.34 mm ² , max: 2 x 1.5 mm ² or 1 x 2.5 mm ²
	XE3NP and XE3SP	Clamping capacity, min: 1 x 0.34 mm ² , max: 1 x 1 mm ² or 2 x 0.75 mm ²
Minimum actuation speed		XE2SP21●1, XESP2151L and XE3SP : 0.01 m/minute XE2NP21●1, XENP2151L and XE3NP : 6 m/minute
Electrical durability		<ul style="list-style-type: none"> ■ Conforming to IEC 60947-5-1 Appendix C ■ Utilisation categories AC-15 and DC-13 ■ Maximum operating rate: 3600 operating cycles/hour ■ Load factor: 0.5

AC supply
50/60 Hz ~
mm inductive circuit

XE2SP21●1, XE2SP2141, XESP2151L

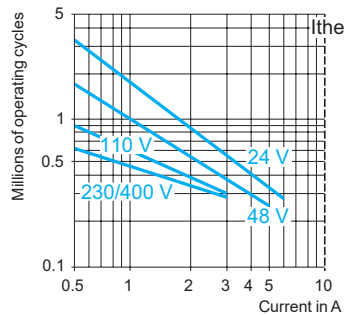

XE2NP21●1, XENP2151L

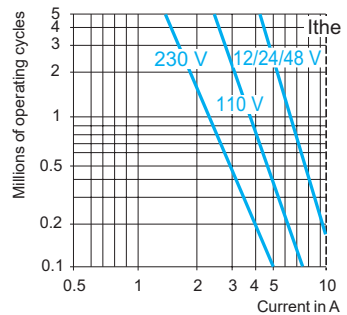

DC supply ---

Power broken in W for 5 million operating cycles.

Voltage	V	24	48	120
mm	W	10	7	4

Power broken in W for 5 million operating cycles.

Voltage	V	24	48	120
mm	W	13	9	7

For XE2SP●151 on ~ or ---, NC and NO contacts simultaneously loaded to the values shown with reverse polarity.

AC supply
50/60 Hz ~
mm inductive circuit

XE3SP●●●●

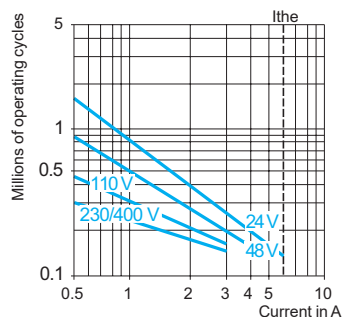

XE3NP●●●●

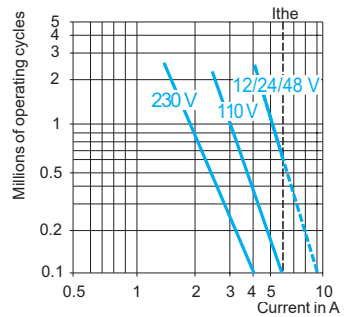

DC supply ---

Power broken in W for 5 million operating cycles.

Voltage	V	24	48	120
mm	W	3	2	1

Power broken in W for 5 million operating cycles.

Voltage	V	24	48	120
mm	W	4	3	2

Limit switches

XC Standard range, Classic format





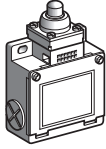
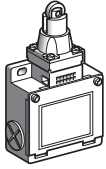
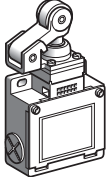
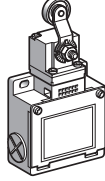
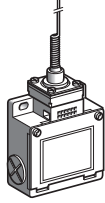





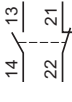



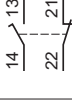



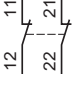



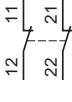



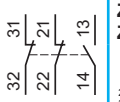

Metal, XCKM

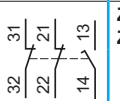
Complete units with 3 cable entries

Type of head	Plunger (fixing by the body)	Rotary (fixing by the body)	Multi-directional, (fixing by the body)
			
			

Type of operator	Metal end plunger	Steel roller plunger	Thermoplastic roller lever plunger, horizontal actuation in 1 direction	Thermoplastic roller lever (1)	"Cat's whisker" (2)
------------------	-------------------	----------------------	---	--------------------------------	---------------------





References of complete units with 3 ISO M20 x 1.5 cable entries (3)

2-pole NC + NO snap action (XE2SP2151)		XCKM110H29 	XCKM102H29 	XCKM121H29 	XCKM115H29 	XCKM106H29
2-pole NC + NO break before make, slow break (XE2NP2151)		XCKM510H29 	XCKM502H29 	XCKM521H29 	XCKM515H29 	XCKM506H29
2-pole NC + NC snap action (XE2SP2141)		ZCKM9H29 + ZCKD10 	ZCKM9H29 + ZCKD02 	ZCKM9H29 + ZCKD21 	ZCKM9H29 + ZCKD15 	ZCKM9H29 + ZCKD06
2-pole NC + NC simultaneous, slow break (XE2NP2141)		ZCKM7H29 + ZCKD10 	ZCKM7H29 + ZCKD02 	ZCKM7H29 + ZCKD21 	ZCKM7H29 + ZCKD15 	ZCKM7H29 + ZCKD06
3-pole NC + NC + NO snap action (XE3SP2141)		ZCKMD39H29 + ZCKD10 	ZCKMD39H29 + ZCKD02 	ZCKMD39H29 + ZCKD21 	ZCKMD39H29 + ZCKD15 	ZCKMD39H29 + ZCKD06
3-pole NC + NC + NO break before make, slow break (XE3NP2141)		ZCKMD37H29 + ZCKD10 	ZCKMD37H29 + ZCKD02 	ZCKMD37H29 + ZCKD21 	ZCKMD37H29 + ZCKD15 	ZCKMD37H29 + ZCKD06
Weight (kg)	0.250	0.255	0.300	0.280	0.250	
Contact operation	 closed  open	(A) = cam displacement (P) = positive opening point		 NC contact with positive opening operation		

References of complete units with 3 Pg 11 cable entries

For complete units with 3 Pg 11 cable entries, delete H29 from the end of the reference. Example: XCKM110H29 becomes XCKM110.

Characteristics

Switch actuation	On end	By 30° cam		By any moving part	
Type of actuation					
Maximum actuation speed	0.5 m/s		1.5 m/s	1 m/s (any direction)	
Mechanical durability (4) (in millions of operating cycles)	20			15	
Minimum force or torque	For tripping	15 N	12 N	8 N	0.1 N.m
	For positive opening	45 N	36 N	24 N	0.25 N.m
Cable entry	3 entries tapped M20 x 1.5 mm for ISO cable gland, clamping capacity 7 to 13 mm				

(1) Adjustable throughout 360° in 5° steps, or in 90° steps by reversing the notched washer.

(2) Value taken with actuation by moving part at 100 mm from the fixing.

(3) Switches with gold contacts or eyelet type connections: please consult our Customer Care Centre.

(4) Limited to 15 million operating cycles for switches with contacts XE3•P.

Limit switches

XC Standard range, Classic format

Metal, XCKM

Complete units with 3 cable entries

XCKM●10
ZCKMD3● + ZCKD10

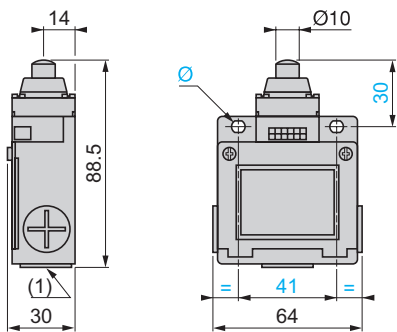

XCKM●02
ZCKMD3● + ZCKD02

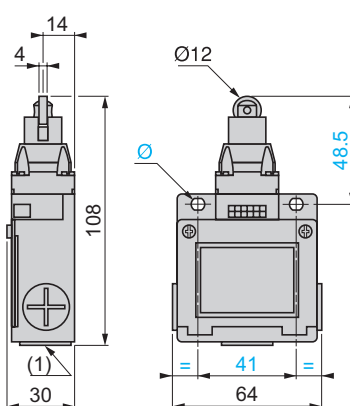

XCKM●21
ZCKMD3● + ZCKD21

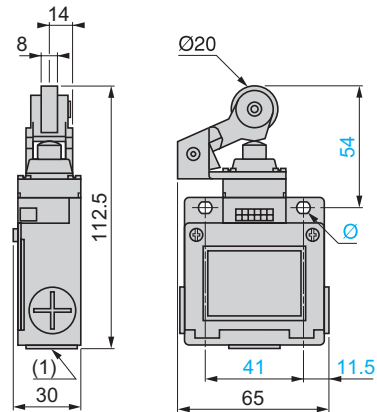

XCKM●15
ZCKMD3● + ZCKD15

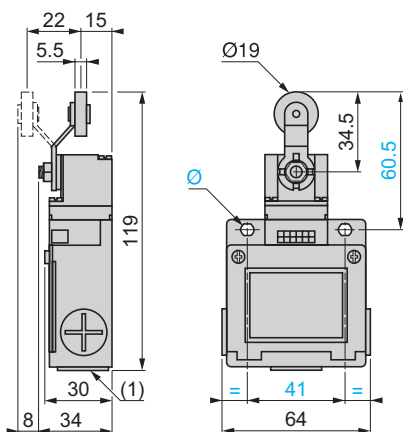

XCKM●06
ZCKMD3● + ZCKD06

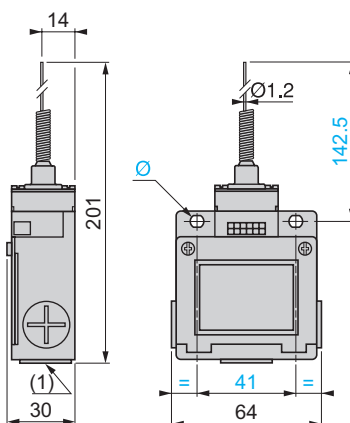

Rear view XCKM●●●, ZCKM●, ZCKMD3●

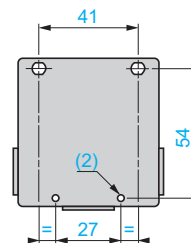

(1) 3 tapped entries for ISO M20 x 1.5 or Pg 11 cable gland or with 1/2" NPT conduit adaptor DE9RA1012.

(2) 2 x Ø 4 H 11, depth 10.

Ø: 2 elongated holes Ø 5.2 x 6.2

Adaptor for 1/2" NPT conduit
DE9RA1012

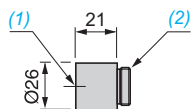

(1) Tapped entry for 1/2" NPT conduit.

(2) Pg 11 threaded sleeve.

Limit switches

XC Standard range, Classic format
Metal, XCKM and XCKL
Variable composition

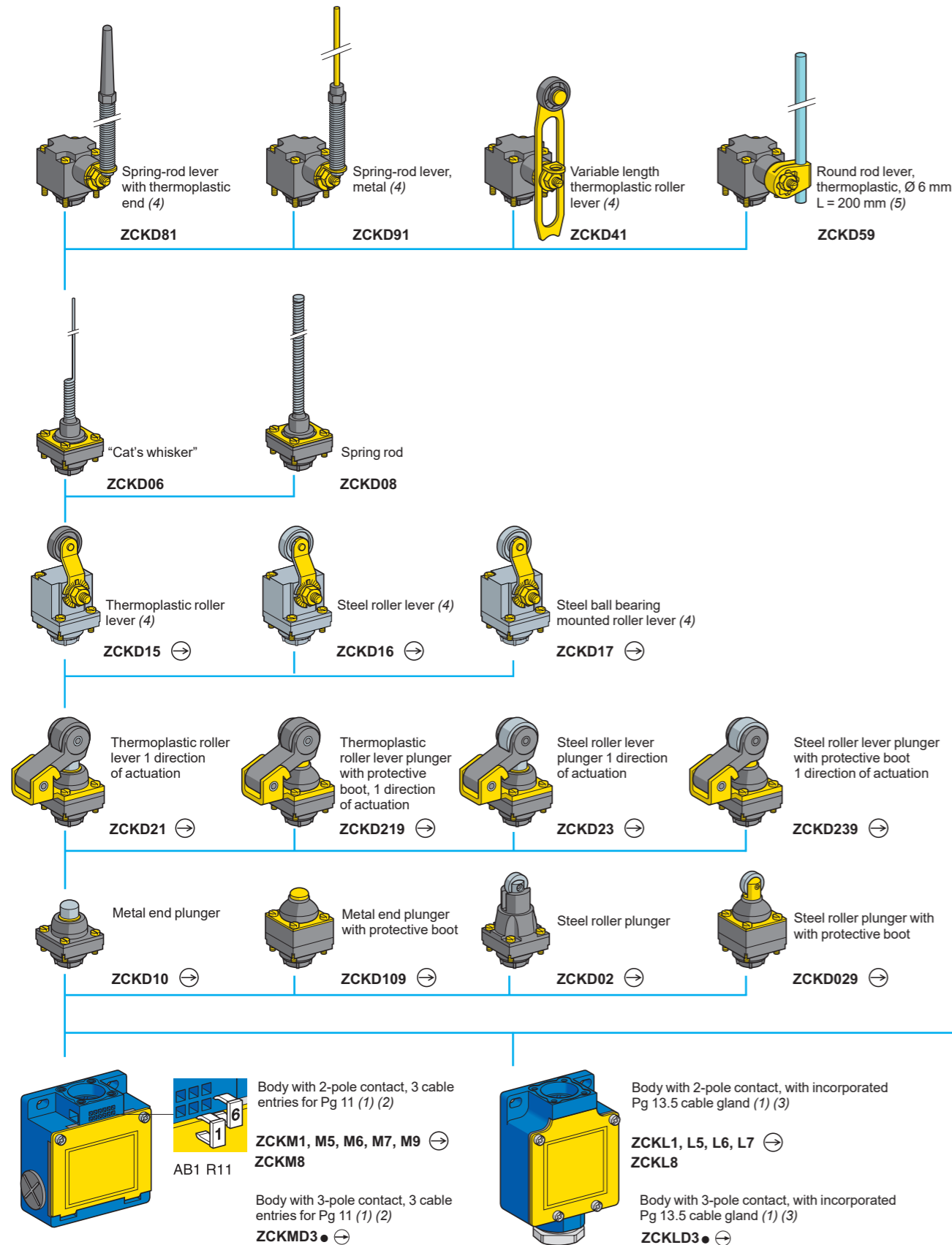

(1) For further information, see page 126.
(2) For 3 cable entries tapped ISO M20 x 1.5, add H29 to the reference. Example: ZCKM1 becomes ZCKM1H29.
For one cable entry with 1/2" NPT adaptor, add H7 to the reference. Example: ZCKM1 becomes ZCKM1H7.
(3) For one cable entry tapped 1/2" NPT, add H7 to the reference. Example: ZCKL1 becomes ZCKL1H7.

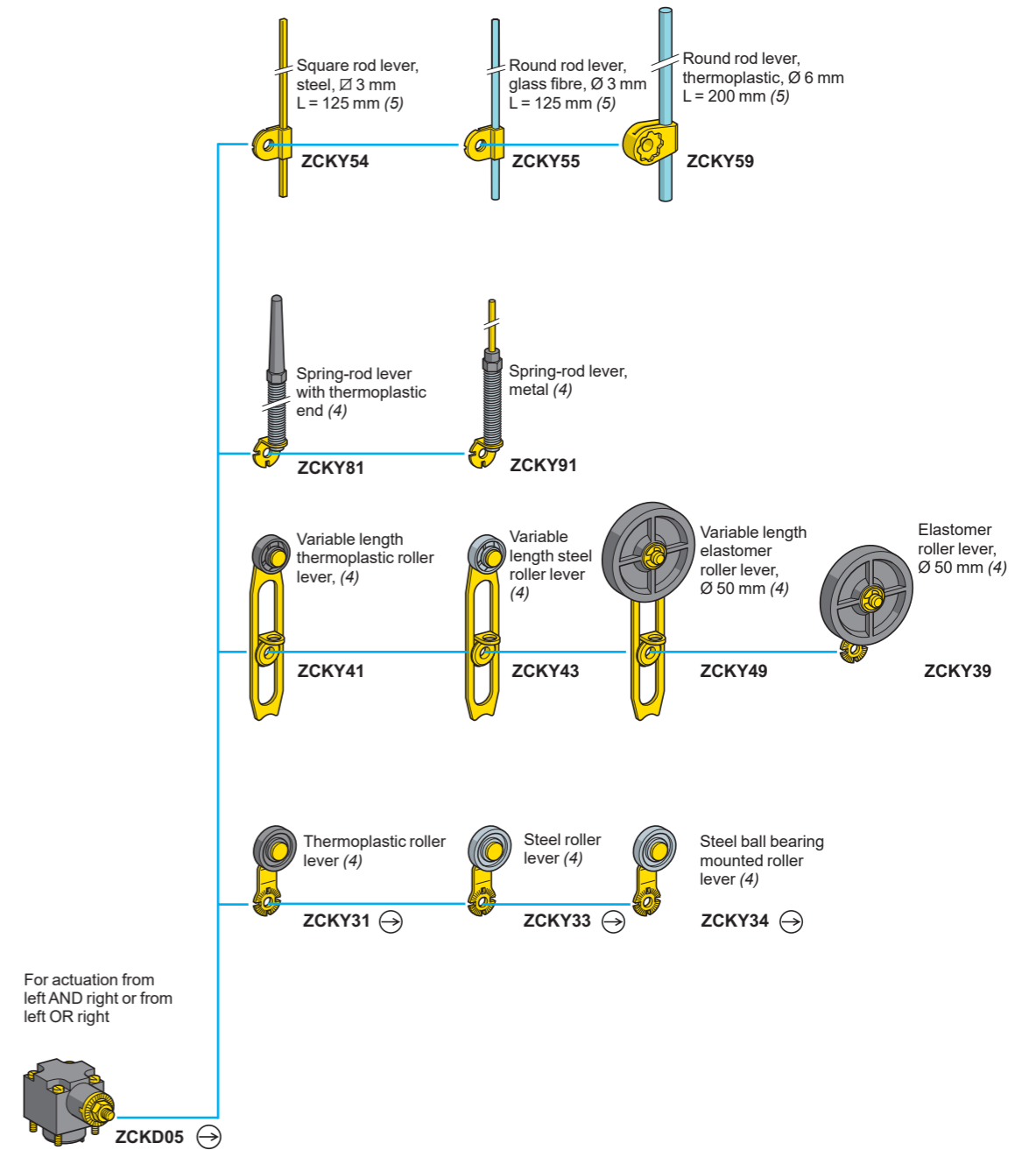

→: head assuring positive opening operation.
(4) Adjustable throughout 360° in 5° steps, or in 90° steps by reversing the notched washer.
(5) Adjustable throughout 360° in 5° steps, or in 45° steps by reversing the lever mounting.

Limit switches

XC Standard range, Classic format
Metal, XCKM and XCKL
Adaptable sub-assemblies

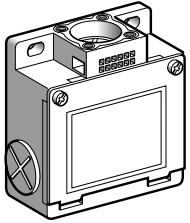

ZCKM●

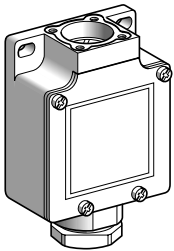

ZCKL●

Bodies with 2-pole contact					
With contact block	Scheme	Positive operation (1)	Cable entry	Reference	Weight kg
For limit switches XCKM					
NC + NO snap action (XE2SP2151)		⊙	Pg 11	ZCKM1	0.210
			ISO M20 x 1.5	ZCKM1H29	0.210
			1/2" NPT (2)	ZCKM1H7	0.210
NC + NO break before make, slow break (XE2NP2151)		⊙	Pg 11	ZCKM5	0.210
			ISO M20 x 1.5	ZCKM5H29	0.210
			1/2" NPT (2)	ZCKM5H7	0.210
NO + NC make before break, slow break (XE2NP2161)		⊙	Pg 11	ZCKM6	0.210
			ISO M20 x 1.5	ZCKM6H29	0.210
			1/2" NPT (2)	ZCKM6H7	0.210
NC + NC simultaneous, slow break (XE2NP2141)		⊙	Pg 11	ZCKM7	0.210
			ISO M20 x 1.5	ZCKM7H29	0.210
			1/2" NPT (2)	ZCKM7H7	0.210
NO + NO simultaneous, slow break (XE2NP2131)		-	Pg 11	ZCKM8	0.210
			ISO M20 x 1.5	ZCKM8H29	0.210
			1/2" NPT (2)	ZCKM8H7	0.210
NC + NC snap action (XE2SP2141)		⊙	Pg 11	ZCKM9	0.210
			ISO M20 x 1.5	ZCKM9H29	0.210
For limit switches XCKL					
NC + NO snap action (XE2SP2151)		⊙	Pg 13.5	ZCKL1 (3)	0.210
			1/2" NPT	ZCKL1H7	0.210
NC + NO break before make, slow break (XE2NP2151)		⊙	Pg 13.5	ZCKL5 (3)	0.210
			1/2" NPT	ZCKL5H7	0.210
NO + NC make before break, slow break (XE2NP2161)		⊙	Pg 13.5	ZCKL6 (3)	0.210
			1/2" NPT	ZCKL6H7	0.210
NC + NC simultaneous, slow break (XE2NP2141)		⊙	Pg 13.5	ZCKL7 (3)	0.210
			1/2" NPT	ZCKL7H7	0.210
NO + NO simultaneous, slow break (XE2NP2131)		-	Pg 13.5	ZCKL8 (3)	0.210
			1/2" NPT	ZCKL8H7	0.210

(1) ⊙: NC contact with positive opening operation.

(2) 3 tapped entries, one with metal adaptor for 1/2" NPT (USASB2-1) conduit.

(3) Pg 13.5 cable gland included with switch.

Limit switches

XC Standard range, Classic format

Metal, XCKM and XCKL

Adaptable sub-assemblies

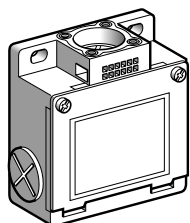

ZCKMD3●

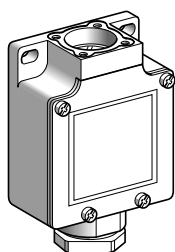

ZCKLD3●

Bodies with 3-pole contact					
With contact block	Scheme	Positive operation (1)	Cable entry	Reference	Weight kg
For limit switches XCKM					
NC + NO + NO snap action (XE3SP2151)		⊖	Pg 11	ZCKMD31	0.210
			ISO M20 x 1.5	ZCKMD31H29	0.210
			1/2" NPT (2)	ZCKMD31H7	0.210
NC + NC + NO snap action (XE3SP2141)		⊖	Pg 11	ZCKMD39	0.210
			ISO M20 x 1.5	ZCKMD39H29	0.210
			1/2" NPT (2)	ZCKMD39H7	0.210
NC + NC + NO break before make, slow break (XE3NP2141)		⊖	Pg 11	ZCKMD37	0.210
			ISO M20 x 1.5	ZCKMD37H29	0.210
			1/2" NPT (2)	ZCKMD37H7	0.210
NC + NO + NO break before make, slow break (XE3NP2151)		⊖	Pg 11	ZCKMD35	0.210
			ISO M20 x 1.5	ZCKMD35H29	0.210
			1/2" NPT (2)	ZCKMD35H7	0.210
For limit switches XCKL					
NC + NO + NO snap action (XE3SP2151)		⊖	Pg 13.5	ZCKLD31 (3)	0.210
			1/2" NPT	ZCKLD31H7	0.210
NC + NC + NO snap action (XE3SP2141)		⊖	Pg 13.5	ZCKLD39 (3)	0.210
			1/2" NPT	ZCKLD39H7	0.210
NC + NC + NO break before make, slow break (XE3NP2141)		⊖	Pg 13.5	ZCKLD37 (3)	0.210
			1/2" NPT	ZCKLD37H7	0.210
NC + NO + NO break before make, slow break (XE3NP2151)		⊖	Pg 13.5	ZCKLD35 (3)	0.210
			1/2" NPT	ZCKLD35H7	0.210

(1) ⊖ : NC contact with positive opening operation.

(2) 3 tapped entries, one with metal adaptor for 1/2" NPT (USASB2-1) conduit.

(3) Pg 13.5 cable gland included with switch.

Limit switches

XC Standard range, Classic format
Metal, XCKM and XCKL
Adaptable sub-assemblies



XE2SP21•1

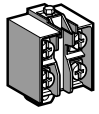

XE2NP21•1

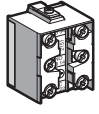

XE3•P21•••



XCKZ09



AB1R11

Contact blocks					
Type of contact	Scheme	For bodies	Positive operation (1)	Reference	Weight kg
2-pole contact					
NC + NO snap action		ZCKM1 ZCKL1	⊕	XE2SP2151	0.020
NC + NO break before make, slow break		ZCKM5 ZCKL5	⊕	XE2NP2151	0.020
NO + NC make before break, slow break		ZCKM6 ZCKL6	⊕	XE2NP2161	0.020
NC + NC simultaneous, slow break		ZCKM7 ZCKL7	⊕	XE2NP2141	0.020
NO + NO simultaneous, slow break		ZCKM8 ZCKL8	-	XE2NP2131	0.020
NC + NC snap action		ZCKM9	⊕	XE2SP2141	0.020
3-pole contact					
NC + NO + NO snap action		ZCKMD31 ZCKLD31	⊕	XE3SP2151	0.035
NC + NC + NO snap action		ZCKMD39 ZCKLD39	⊕	XE3SP2141	0.035
NC + NC + NO break before make, slow break		ZCKMD37 ZCKLD37	⊕	XE3NP2141	0.035
NC + NO + NO break before make, slow break		ZCKMD35 ZCKLD35	⊕	XE3NP2151	0.035

(1) ⊕: NC contact with positive opening operation or sub-assembly assuring positive opening operation.

Accessories for limit switches XCKM			
Description	Sold in lots of	Unit reference	Weight kg
Tap-off terminal for cabling continuity	1	XCKZ09	0.010
Clip-in markers (strips of 10 numbers: 0 to 9) Other markers, please consult our Customer Care Centre.	25	AB1R11	0.002

Other versions Gold flashed contacts.
Please consult our Customer Care Centre.

Limit switches

XC Standard range, Classic format
Metal, XCKM and XCKL
Adaptable sub-assemblies

Heads ZCKD10, D109 with body

ZCKM1, L1

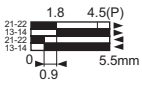

ZCKM5, L5

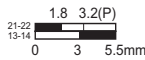

ZCKM6, L6

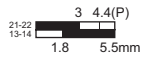

ZCKM7, L7

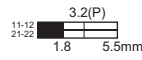

ZCKM8, L8

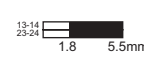

ZCKM9

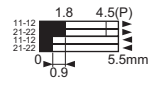

ZCKMD39, LD39

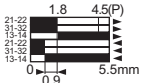

ZCKMD37, LD37

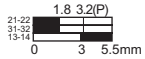

ZCKMD31, LD31

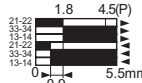

ZCKMD35, LD35

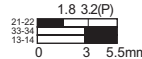

Heads ZCKD02, D029 with body

ZCKM1, L1

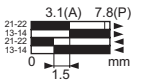

ZCKM5, L5

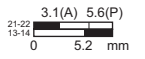

ZCKM6, L6

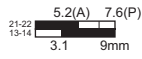

ZCKM7, L7

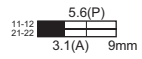

ZCKM8, L8



ZCKM9

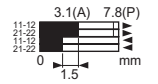

ZCKMD39, LD39

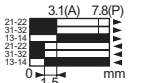

ZCKMD37, LD37

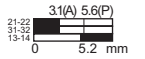

ZCKMD31, LD31

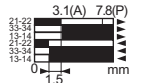

ZCKMD35, LD35

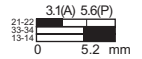

Heads ZCKD21, D23, D219, D239 with body

ZCKM1, L1

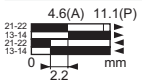

ZCKM5, L5

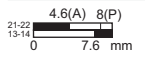

ZCKM6, L6



ZCKM7, L7



ZCKM8, L8

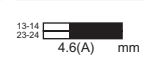

ZCKM9

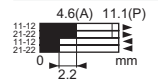

ZCKMD39, LD39

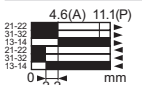

ZCKMD37, LD37

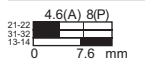

ZCKMD31, LD31

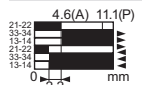

ZCKMD35, LD35

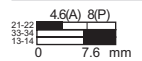

Heads ZCKD15, D16, D17 with body

ZCKM1, L1

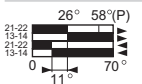

ZCKM5, L5

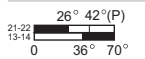

ZCKM6, L6

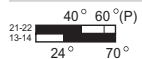

ZCKM7, L7

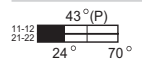

ZCKM8, L8

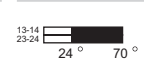

ZCKM9

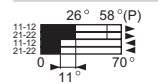

ZCKMD39, LD39

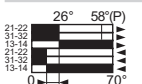

ZCKMD37, LD37

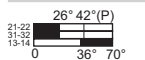

ZCKMD31, LD31

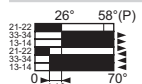

ZCKMD35, LD35

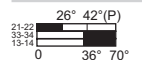

Heads ZCKD41, D59, D81, D91 with body

ZCKM1, L1

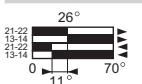

ZCKM5, L5

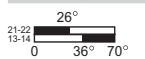

ZCKM6, L6

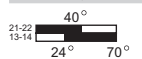

ZCKM7, L7



ZCKM8, L8



ZCKM9

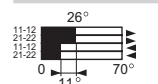

ZCKMD39, LD39

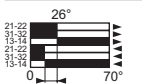

ZCKMD37, LD37

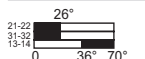

ZCKMD31, LD31

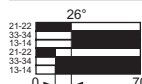

ZCKMD35, LD35

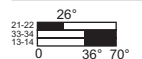

Heads ZCKD06, D08 with body

ZCKM1, L1

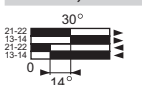

ZCKM5, L5

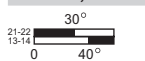

ZCKM6, L6

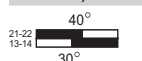

ZCKM7, L7



ZCKM8, L8



ZCKM9

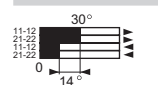

ZCKMD39, LD39

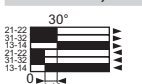

ZCKMD37, LD37

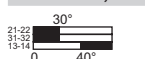

ZCKMD31, LD31

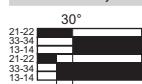

ZCKMD35, LD35

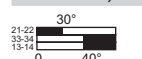

Contact operation

■ closed
□ open

(A) = cam displacement
(P) = positive opening point

Limit switches

XC Standard range, Classic format

Metal, XCKM and XCKL

Adaptable sub-assemblies

Bodies with contacts

ZCKM1, M5, M6, M7, M8, M9, MD3●, MD3H●29, MD3●H7
ZCKM1H29, M5H29, M6H29, M7H29, M8H29, M9H29
ZCKM1H7, M5H7, M6H7, M7H7, M8H7

ZCKL1, L5, L6, L7, L8, LD3● (with incorporated Pg 13.5 cable gland)
ZCKL1H7, L5H7, L6H7, L7H7, L8H7, LD3●H7 (with 1/2" NPT cable entry)

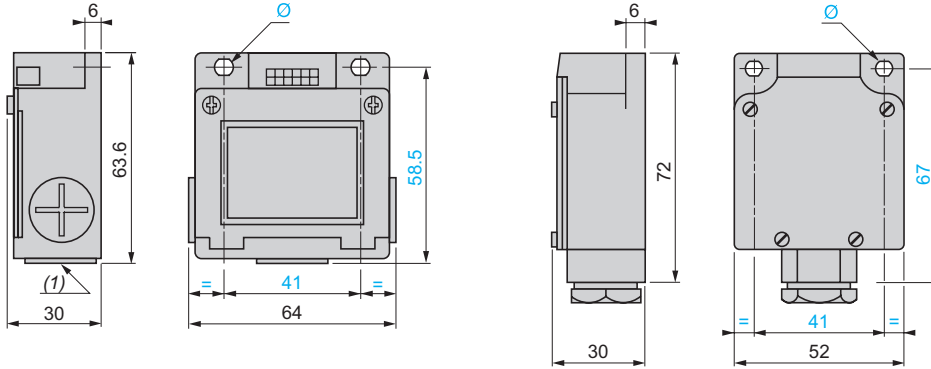

Adaptor for 1/2" NPT conduit

DE9RA1012

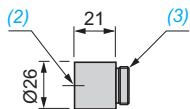

(1) 3 tapped entries for ISO M20 x 1.5 or Pg 11 cable gland.

Ø: 2 elongated holes Ø 5.2 x 6.2

(2) Tapped entry for 1/2" NPT conduit.

(3) Pg 11 threaded sleeve.

Limit switches

XC Standard range, Classic format

Metal, XCKM and XCKL

Adaptable sub-assemblies

Plunger heads

ZCKD10

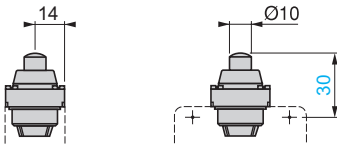

ZCKD109

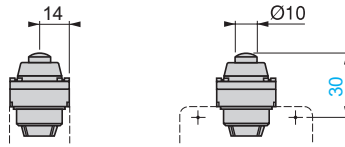

ZCKD02

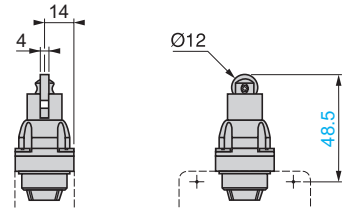

ZCKD029

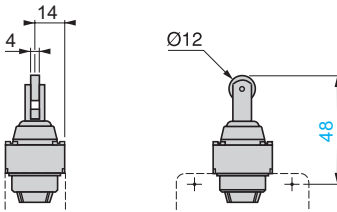

ZCKD21, ZCKD23

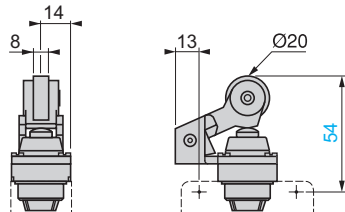

ZCKD219, ZCKD239

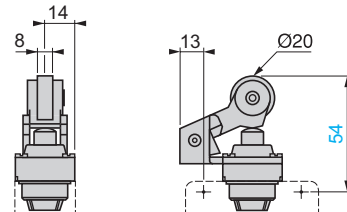

Rotary heads

ZCKD15, ZCKD16, ZCKD17

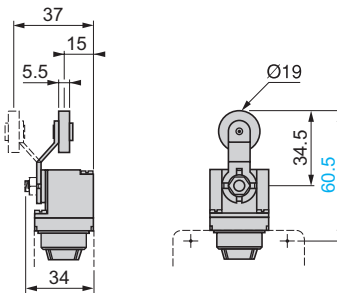

ZCKD41

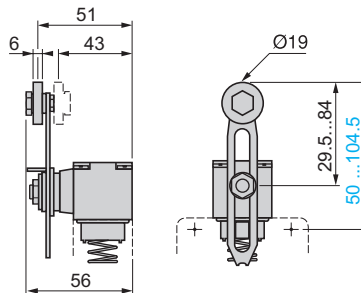

ZCKD59

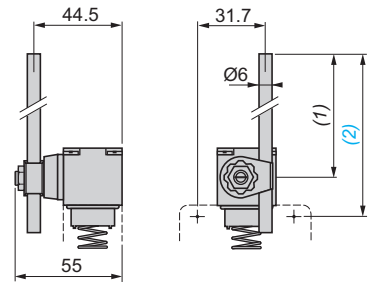

ZCKD81

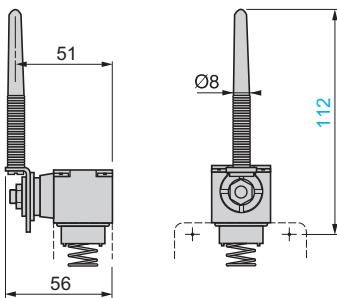

ZCKD91

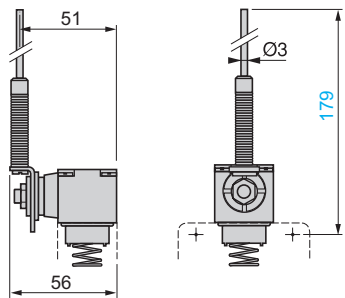

Multi-directional heads

ZCKD06

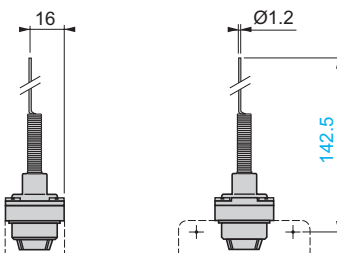

ZCKD08

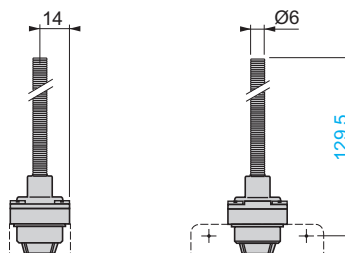

(1) 190 max.
(2) 215.5 max.

Note: operating lever spindle threaded M6.